

escomatic D2 FLEXSPEED

THE ECONOMICAL SOLUTION



TECHNICAL DATA

Maximum toolhead capacity	5	mm
Maximum stroke length	80	mm
Amount of cutting tools	2	
Toolhead rotation speed, continuously variable	4 000/8 000	min ⁻¹
Straightener rotation speed, continuously variable	4 000/8 000	min ⁻¹
Cam shaft rotation speed programmable per section of degrees	1/100	min ⁻¹

General specifications

Coolant	Oil	
Weight	1050	kg
Floor-space (W x L)	1'560 x 1'000	mm

Modifications reserved

The ESCO FLEXSPEED system allows machining to be optimised while guaranteeing an extremely high level of productivity. This increases the advantages of cam machine performance. Thanks to the electronic control system, the revolution of the cam shaft can be programmed for specific areas. For example, the feed rate can be reduced for parting and increased for turning; this means that the slowest process no longer determines the overall cycle time. In addition the spindle speeds and straightening speeds can be continuously adjusted (no more changing pulleys). This means that the parameters of each operation can be optimised individually. The result is a significant improvement in the quality of the parts which are produced, both in meeting tolerances and in surface finish. More than 15% gain in productivity are regularly achieved.

The new lubrication system eliminates the need for compressed air to the machine.

All sets of cams and tools which are already in use for older escomatic D2 machines can also be used on the D2 FLEXSPEED.

ACCESSORIES

The escomatic D2 FLEXSPEED is equipped with a counter collet only but can be equipped with the following optional accessories:

Constant threading of the stock (D2)

This unit is mounted between the straightener and the feeding device. It threads the material continuously while the parts are machined (D2-43).

End-working milling (D2)

The standard counter collet can be accommodated with an end-working milling attachment (D2-PMF).

Overlapped accurate knurling operations (D2)

An accurate knurling device is available and mounted in line with the counter collet. Controlled with a hydraulic system reaching up to 2.8 tons pressure, this unit is designed for accurate knurling and thread rolling operations, which are overlapped with the turning operations (D2-47).

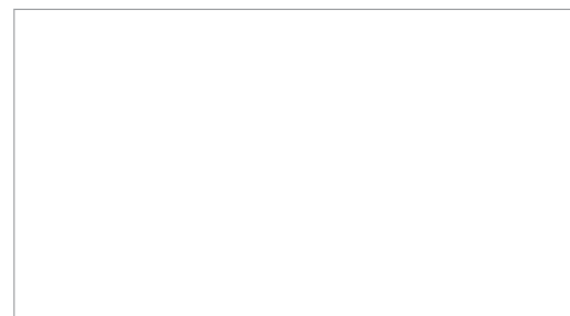

escomatic

D2 FLEXSPEED

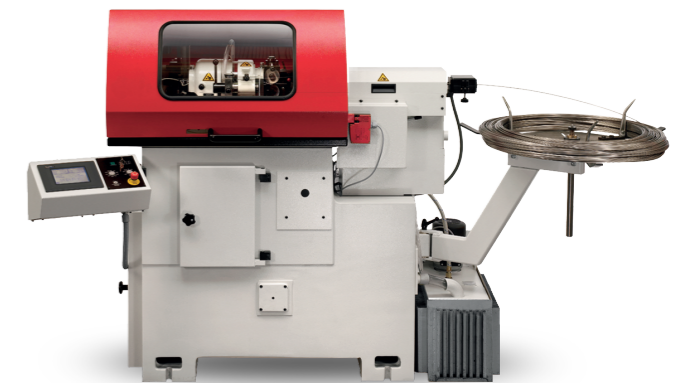
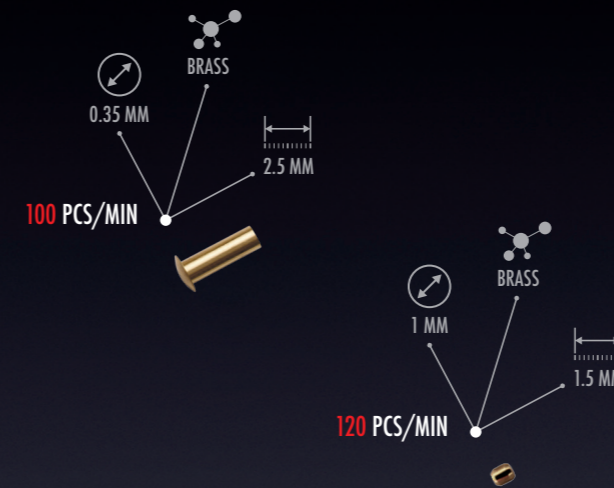

THE ECONOMICAL SOLUTION

escomatic D2 FLEXSPEED

THE ECONOMICAL SOLUTION

escomatic Concept

Unlike conventional lathes, escomatic lathes are based on a unique concept. The material, which is coil stock or bar, does not rotate. The cutting tools mounted onto the spinning tool head rotate around the material. This concept equally qualified for the manufacturing of small, medium and large lot size parts, contributes to the extremely high performance and cost savings achieved with escomatic machines.

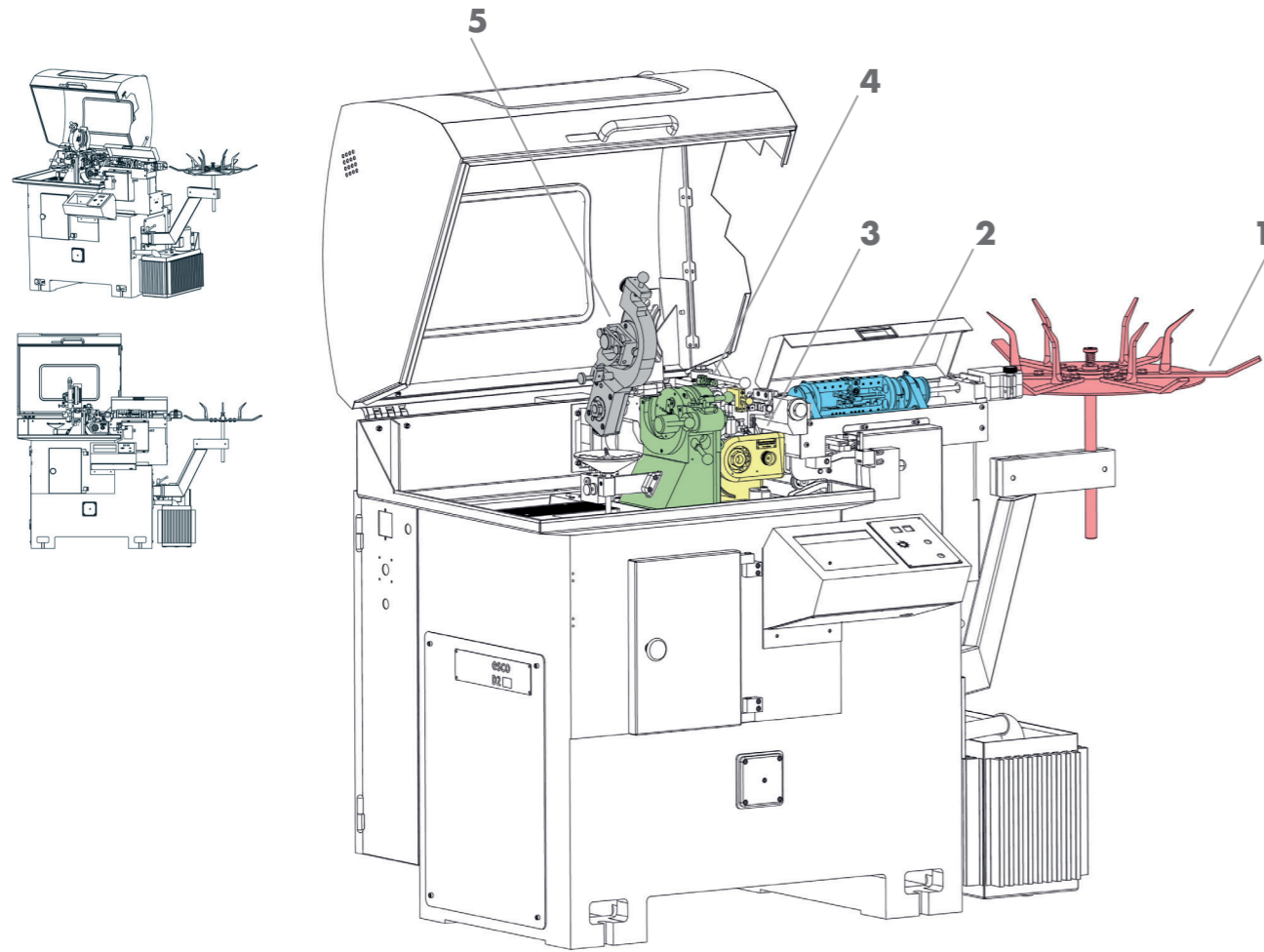

Applications:



17 PCS/MIN
(TITAN Gr.5)



12.5 PCS/MIN
(420F/1.4035)



31.5 PCS/MIN
(BRASS)



22 PCS/MIN
(ALU)

escomatic by ESCO SA

escomatic.ch



MATERIAL FEED

The material is supplied into the machine from coil. A coil, depending on the type of material, usually has 30 to 50 kg and is unrolled from a reel supported by the machine. The material is pulled across the machine by the material feed system.

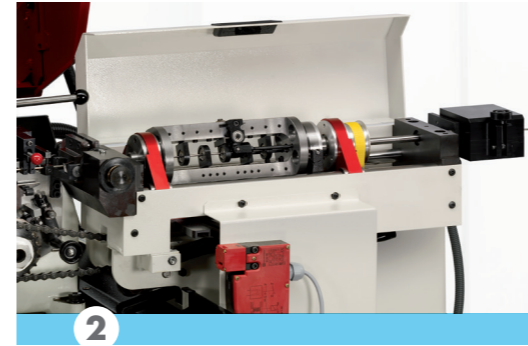

MATERIAL STRAIGHTENING

The material is fed into the machine from a coil which becomes bar stock after the straightening process. It produces a bar with a straightness quality equivalent to standard bar stock.

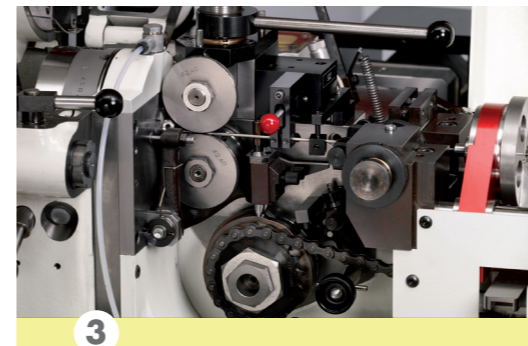
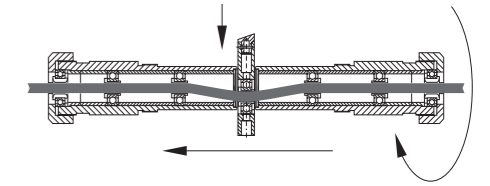

MATERIAL FEEDING

The material is clamped between a set of grooved rollers and their rotation controls the feeding. The clamping pressure is adjustable and the grooves have the shape of the wire. With this principle and the closeness of the guide bushing, very small wire can be machined without bending or breaking (down to 0.30 mm).

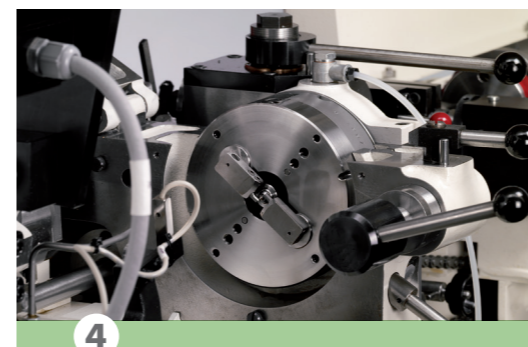

TURNING

While the material is held by a guide bushing, the turning and chip removal is performed by the unique escomatic principle. This consists in having the cutting tools rotating around the material with a speed up to 8000 rpm. When cutting off, the counter collet holds the machined part for a perfect flatness and a cut off without burr.

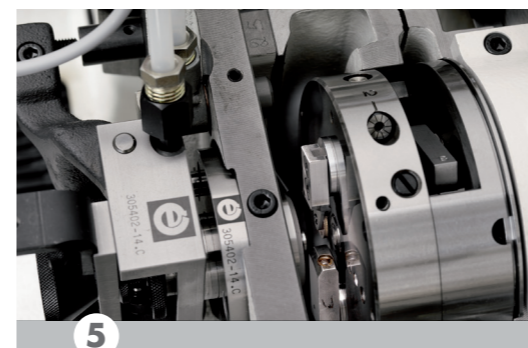

COUNTER COLLET

Before cutting off of the finished part from the stock material, the work piece is clamped by the fixed collet, or for parts with complex geometry by an optional moving counter collet. After cut off, the part is pushed by the following work piece across the counter collet and ejected into a small container.